

DK 30/T-EN54-PG



- High sound pressure level
- Weather-proof
- BS 5839



EN 54-24:2008

Ref. Nr.: 003-13

ID-Code: SAA-LS03

1438-CPR-0242

ic audio GmbH, Boehringerstraße 14a,
D-68307 Mannheim, Germany

CE-Symbol gemäß Richtlinie 93/68EWG

The 30W powered speaker is equipped with a 100V line transformer with 4 power adjustments, also low-impedance operation (20 ohms) is possible. The impact-resistant ABS housing UL94V0 in RAL 7035 guarantees long-term stability. For additional reliability, a ceramic block and a thermal fuse are provided.

The speaker is also secured with the high protection class IP 66 against the security risks of environmental influences. The speaker is compliant with the British Standard BS 5839, Part 8.

The PG11 cable glands on the back of the speaker allow quick and easy connection.

Included is a U-shaped, stainless steel universal mount for flexible installation. Optionally available is a mast bracket (MB) for approx. 90-200 mm mast diameter.

To operate the product according to EN 54-24, an equalizer has to be used as described in the user manual.

Technical Data (Electrical)

Description	DK 30/T-EN54-PG
Power	30/20/10/5 (20) W
Impedance (100V)	333/500/1000/2000 ohm
Frequency Range	592 - 6.900 Hz
Frequency Response	250 - 15.000 Hz
SPL IEC268-5, 1W/1m	97,0 dB
SPL EN54-24, Pmax/4m	96,0 dB
Sensitivity EN54-24, 1W/4m	85,0 dB
Sensitivity EN54-24, 1W/1m	97,9 dB
Dispersion -6dB, 500Hz	h/v 155°
Dispersion -6dB, 1KHz	h/v 110°
Dispersion -6dB, 2KHz	h/v 65°
Dispersion -6dB, 4KHz	h/v 35°

Technical Data (Mechanical)

Dimensions	235x351 mm
IP Rating	IP66
Weight (net)	2,27 kg
Temperature range	-25 / +70 C°
Mounting	Mounting bracket
Connector	ceramic block
Terminal diameter	3,2 mm
Maximum cable passage	8 mm ²
Colour	RAL 7035

Product Attributes



Technical Drawing

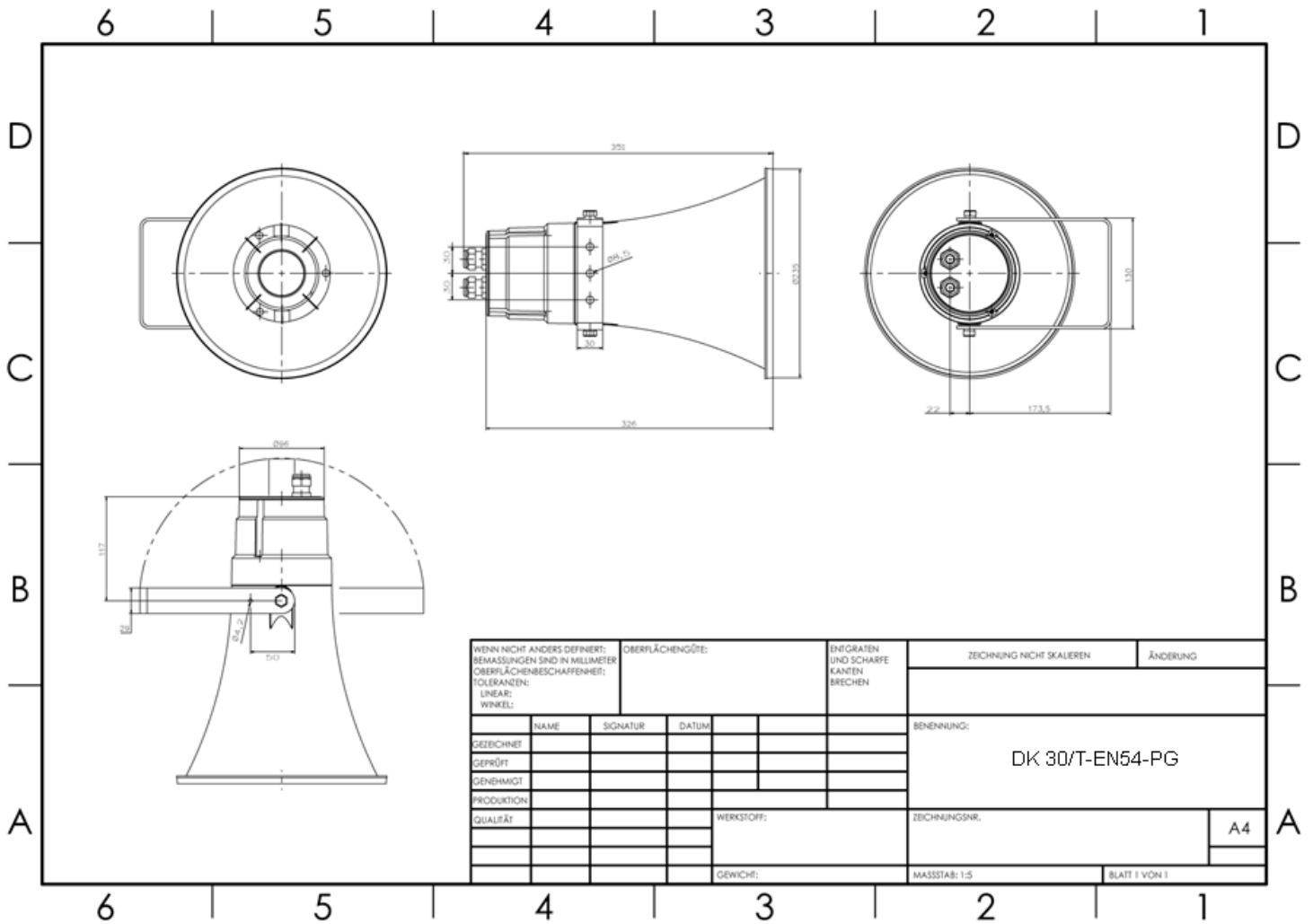

Frequency Response Diagram

Sensitivity

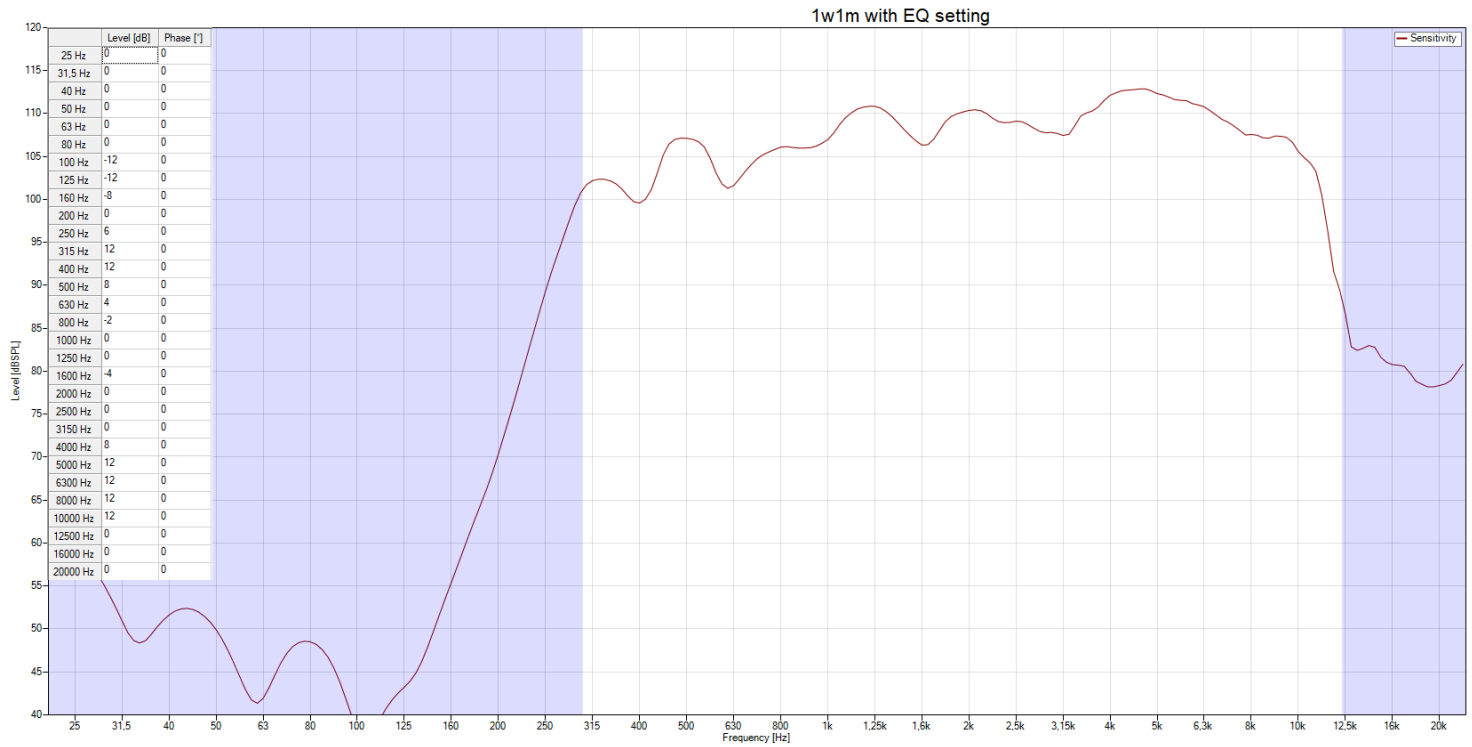

SPL Max

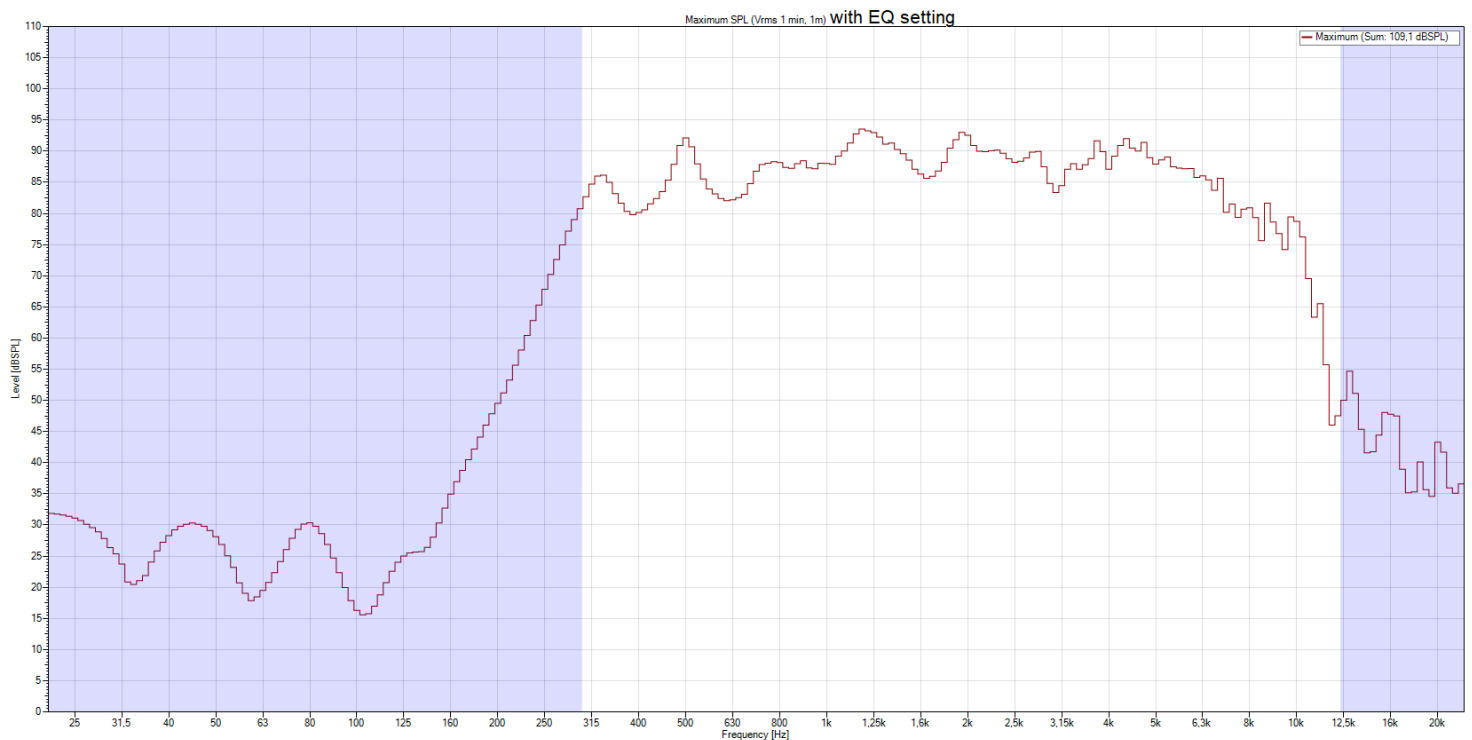

Isobar

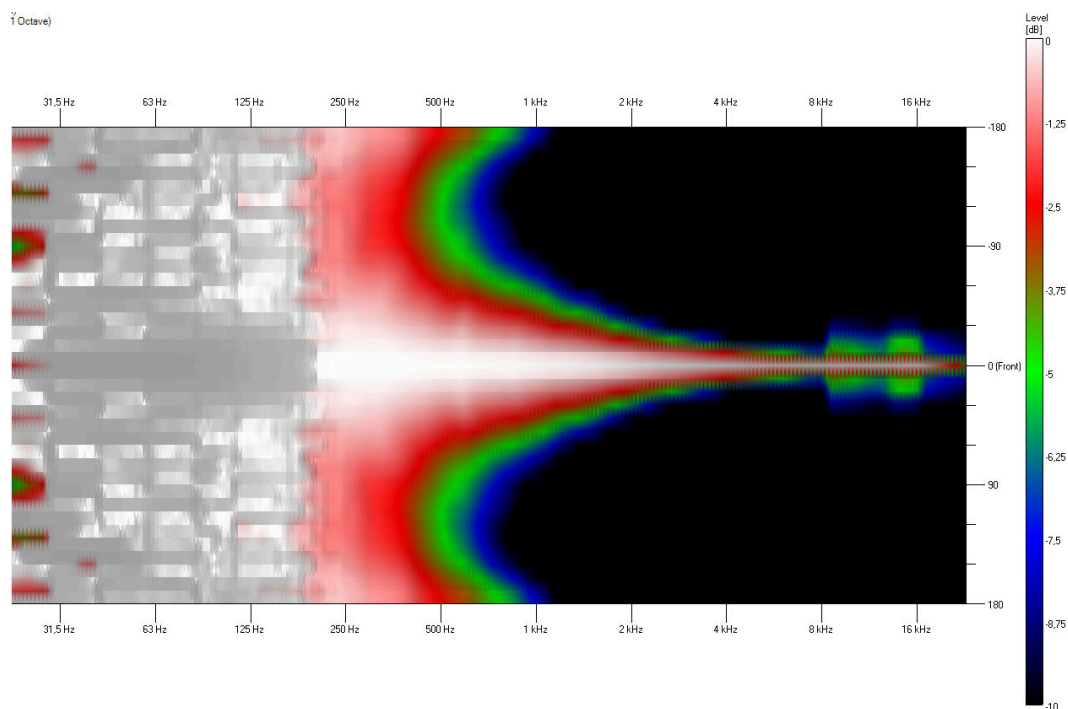

Polar Diagram

Polar Diagram 500Hz

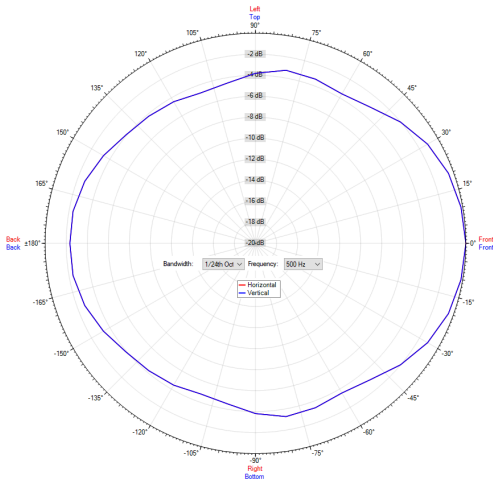

Polar Diagram 4000Hz

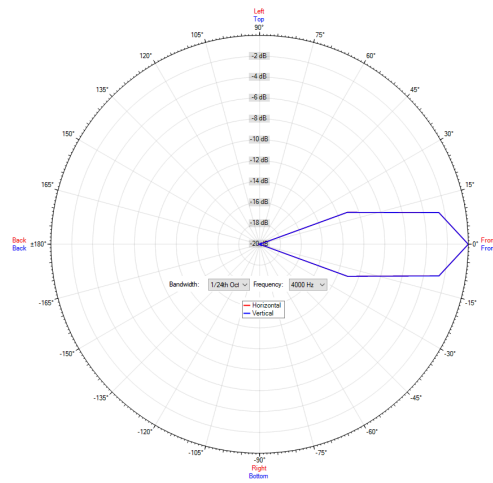

Polar Diagram 1000Hz

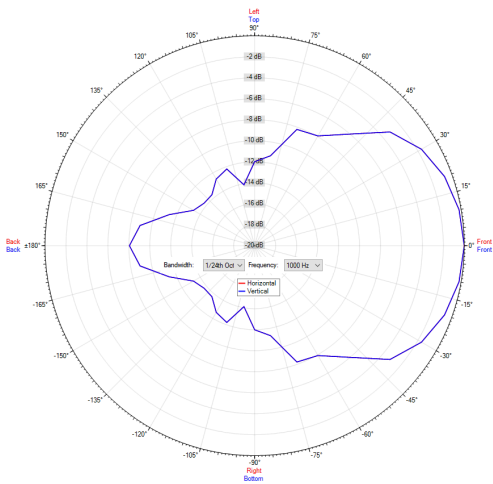

Polar Diagram 8000Hz

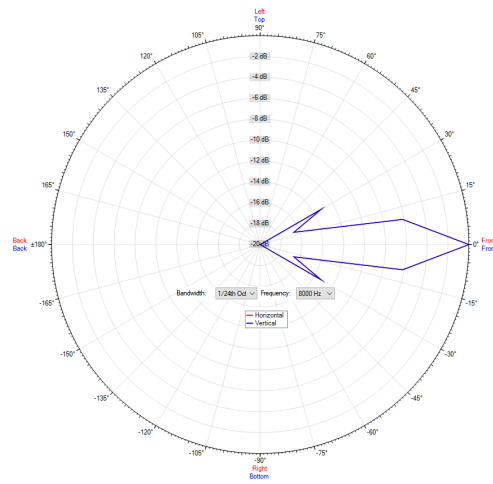

Polar Diagram 2000Hz

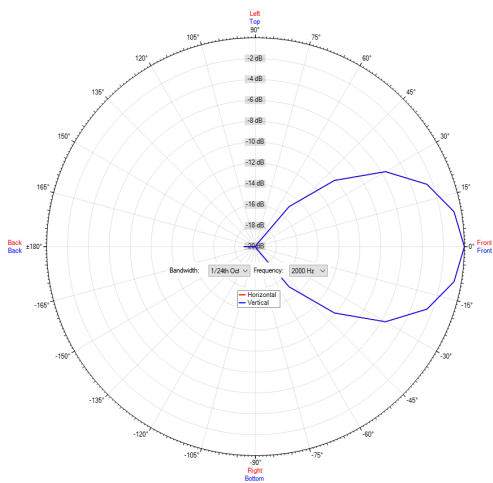

ic audio loudspeakers are tested and classified according to the IEC standard 60529 (degree of protection by enclosure) against the penetration of foreign objects and moisture. The classification is conforming to standards through characterization with a fixed code. This code consists of the letters IP (International Protection) followed by two digits. The first digit indicates the degree of protection against dust and the second digit the degree of protection against water. Please note that the testing of the products has been carried out in laboratory conditions which are not always 100% comparable with the conditions of different installation environments. This protection can be reduced due to normal wear and tear depending on the installation environment.

RoHS compliant (2011/65/EU)

The IP rating specified is based on ic audio test results, not on CNBOP-PIB test results. Certification only verifies the minimum requirements for EN54-24 compliance.



Article Nr.: 20205825-PG
Packing Unit: 6

